

# Economical Ultrasonic Transit-Time Liquid Flow Meter

## FEATURES

- One meter for a wide range of pipe sizes from 2 to 48 inches (50.8 to 1200 mm)
- Clamp-on, encapsulated IP 68 sensors require no pipe cuttings, no plant shutdown, and are hygienic measurements, leading to lower installation and labor costs
- Measurement is independent of fluid conductivity for a wider applicability compared to magnetic meters
- Programmable frequency output and VAC power emulates turbine/propeller meters
- Accuracy +/- 1.0% of reading from 1.6 to 40 ft/s (0.49 to 12 m/s)
- Repeatability +/- 0.3% of reading
- Wide operating temperature range 32°F to 140°F (0°C to 60°C)
- 16 tactile keys with 12 dual-function keys for easy setup
- Configurable pulse and relay output
- 10 to 36 VDC at 1A power supply
- Daily, monthly, and yearly totalized flow
- Lightweight 1.5 lb (0.7 kg); PC/ABS IP 65 transmitter
- Modbus RTU, RS-485

# InnovaSonic<sup>®</sup> 203



## DESCRIPTION

Sierra's economical InnovaSonic<sup>®</sup> 203 ultrasonic liquid flow meter delivers highly accurate and repeatable flow measurement for liquids at an economical price. Ideal for pipes up to 48 inches (1200 mm) in diameter, the 203 promises accuracy to +/-1.0% of reading, repeatability of +/-0.3% of reading and a temperature range of 32°F to 140°F (0°C to 60°C).

The 203 offers low power consumption and high reliability at a very competitive price. An easy to read display and dual-function quick keys make setup quick and simple.

The 203 features a programmable frequency output, a relay output and a programmable current loop output. RS-485 and Modbus RTU are standard.

The InnovaSonic 203 is packaged in a lightweight polycarbonate IP 65 housing and includes clamp-on encapsulated IP 68 sensors that are easy to install and require no pipe cutting, reducing installation and labor costs.



[www.sierrainstruments.com](http://www.sierrainstruments.com)



**PERFORMANCE SPECIFICATIONS**

- Accuracy**  
+/- 1.0% of reading from 1.6 to 40 ft/s (0.49 to 12 m/s)
- Repeatability**  
+/- 0.3% of reading
- Pipe Size**  
2 to 48 inches (50.8 to 1200 mm)

**OPERATION SPECIFICATIONS**

- Flow Range**  
1.6 to 40 ft/s (0.49 to 12 m/s)
- Temperature**  
Ambient: 14°F to 122°F (-10°C to 50°C)  
Operating: 32°F to 140°F (0°C to 60°C)
- Power Supply**  
10 to 36 VDC at 1A
- Output**
  - Analog: 4 to 20 mA current loop (max load 750 Ω)
  - Pulse output: 0 to 9999 Hz, OCT, (min. and max. frequency is adjustable)
  - Relay output: SPST, max 1 Hz, (0.3 A@ 125VAC or 1A @ 30VDC)
  - Digital output: Modbus RTU, RS-485
- Keypad**  
16 tactile keys with 12 dual-function keys for easy setup
- Display**  
40 character, 2 line (20x2) lattice alphanumeric, backlit LCD
- Humidity**  
Up to 99% RH (non-condensing)

**PHYSICAL SPECIFICATIONS**

- Transmitter**  
NEMA 4X, IP 65 (PC/ABS)
- Transducer**  
Encapsulated design IP 68  
Standard cable length: 30 ft (9 m)  
Maximum cable length: 100 ft (30 m)
- Weight**  
Transmitter: approximately 1.5 lb. (.7 kg)  
Transducer: approximately 0.9 lb. (0.4 kg)

**DIMENSIONS**

Front View 203 Transmitter

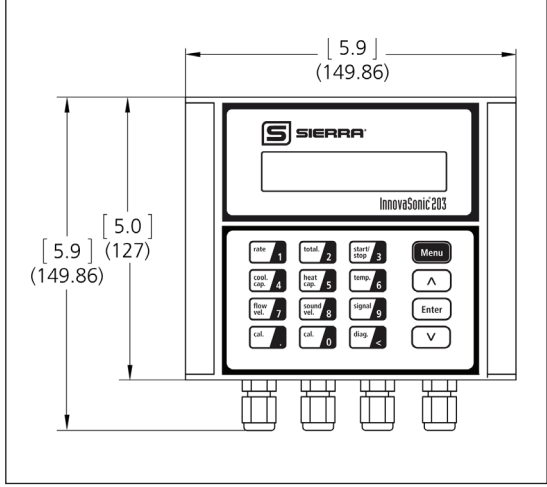

Side View 203 Transmitter

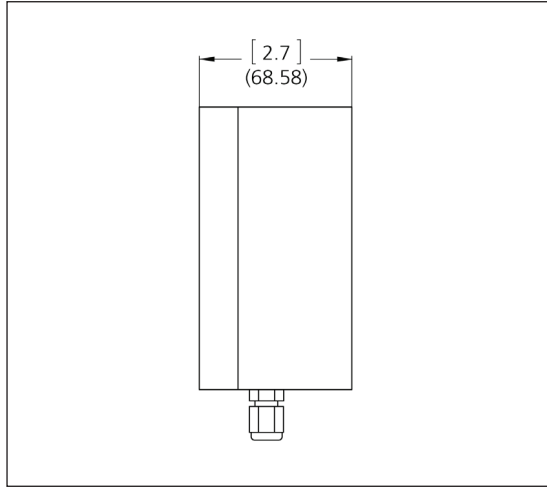

Front View Clamp-on Transducers

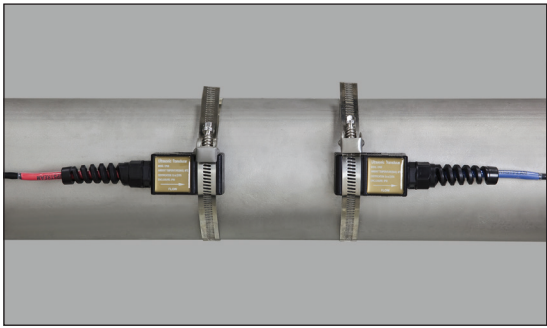

## OPTIMAL INSTALLATION LOCATIONS

### Transducer Installation Examples

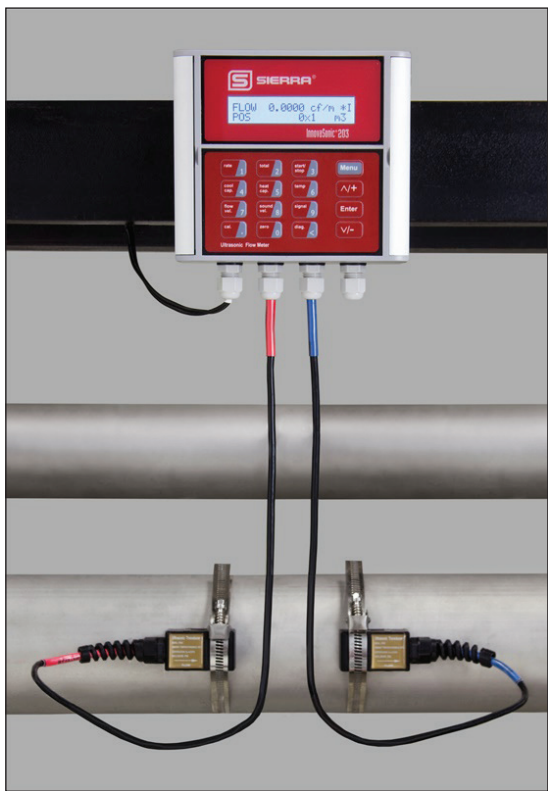
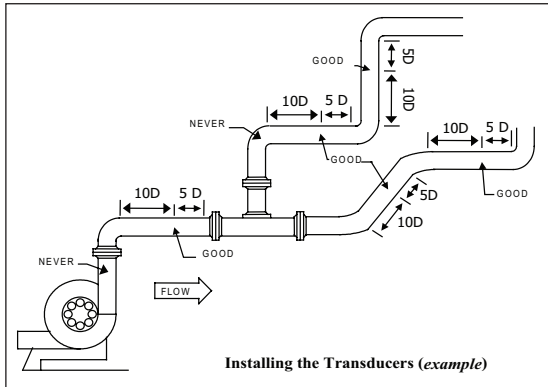

## TRANSDUCER SPACING REQUIREMENTS

### Z Method Transducer Spacing

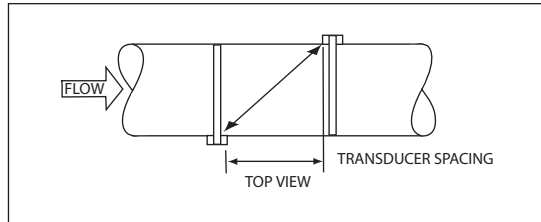

### V Method Transducer Spacing

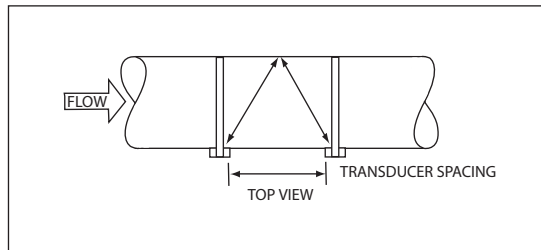

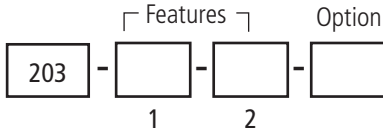

Instructions: To order the 203, please fill in each number block by selecting the codes from the corresponding features below.

Parent Number	
<b>203</b>	InnovaSonic 203® Economical ultrasonic transit time liquid flow meter; clamp-on transducers (CP) included in base price.
Feature 1: Outputs	
<b>4</b>	OCT, Relay, RS-485, 4 to 20 mA current loop (max load 750 Ω), Modbus RTU
Feature 2: Transducers	
<b>CP</b>	Clamp-on transducers. Operating temperature 32°F to 140°F (0°C to 60°C). Standard 30 ft. (9 m). Included in base price.
<b>CP (X)</b>	Special length up to 100 ft. (30 m)
Option: NIST Traceable Certificate	
<b>NIST</b>	5-point calibration certification traceable to NIST. Add two weeks to standard delivery.

Note: Transducers included in base price.

# Flexibility And Options.

## Learn About Our New Rental Program.

### How To Apply For Rental

- Visit <http://sierrainstruments.com/rental>
- Email [Rental@SierraInstruments.com](mailto:Rental@SierraInstruments.com)



In Stock Products. Ship In Three Days.\*

<https://sierrainstruments.com/shop/203>



\*Disclaimer: Dependent on availability of stock.